



Underglass Awning

markilux 779 / 779 tracfix

The perfect underglass awning for large areas. The angular frame design throughout empahsizes design emphasizes the lines of each and every glass canopy.



reddot design award
winner 2017



markilux.com

markilux

safe timeless beautiful

Product characteristics

Wind resistance class 2 | 3 (depending on size)
 Beaufort 5 → 28–37 km/h → 7.5–10.4 m/s → 17–23 mph
 Beaufort 6 → 38–48 km/h → 10.5–13.4 m/s → 24–30 mph



1 side view, motor operation, flat track brackets

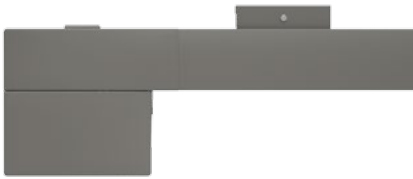

1 side view, manual operation with crank handle

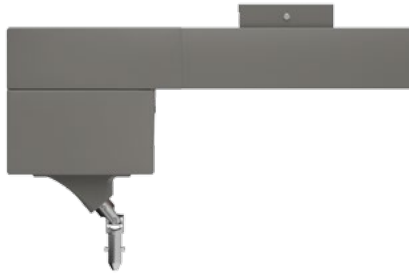

2 cable feed system in lighting units

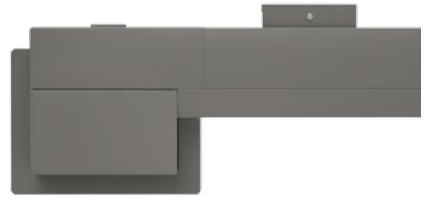

3 shadeplus during extension

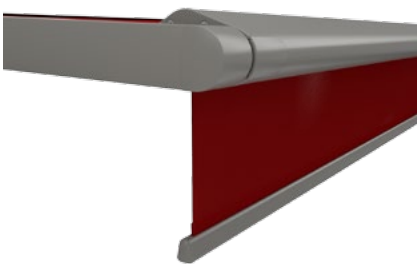

4 tracfix cover guidance – no gap between cover and track ¹⁾

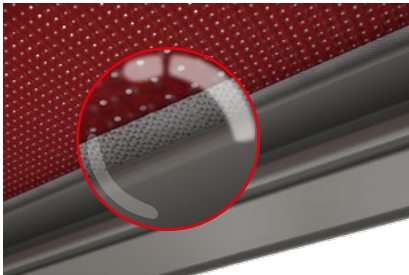

5 front profile finishes flush with the ends of the guide tracks

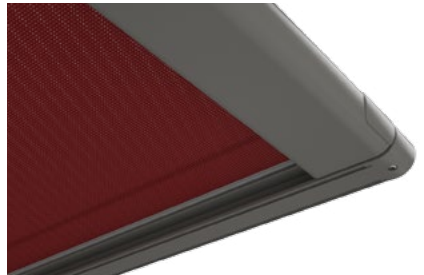

6 LED-Line fitted to the guide track and cover support tube ¹⁾



7 LED-Line fitted to the guide track and LED-Spots in the cover support tube ¹⁾



8 LED-Line fitted to the guide track ¹⁾, cover support by means of a stainless steel wire



¹⁾ optional configuration

Product characteristics

Description

- underglass awning with cleanly designed, quadratic cassette and harmoniously matched, angular guide tracks. The ingenious tensioning system and the sturdy design allow areas of up to 27 m² to be shaded.

Special features

- fully encompassing cassette that protects the cover perfectly
- the tried and tested tensioning system – with drive belts and integrated gas pistons – delivers optimum cover tension in any phase of extension
- tracfix optional: the continuous lateral cover guidance system that leaves no gap between the cover and guide tracks – gives improved wind stability and a cleaner appearance
- various lighting combinations available: light strip LED-Line in the guide tracks, LED-Line in the cover support tube or LED-Spots fitted to the cover support tube – individually configurable lighting options providing a pleasant atmosphere in the evening
- option of a drop valance with a height of 150 cm or 210 cm (depending on the fabric series chosen) – protection against low-lying sun, wind and inquisitive glances integrated into the front profile, with manual operation
- the broad range of brackets with patented clip-on system offers individual fixture solutions

Dimensions

- single unit: 60 cm – 600 cm in width, maximum extension 600 cm (depending on the width)
- maximum dimensions, width × extension: 400 cm × 600 cm / 600 cm × 450 cm (without tracfix system)
- maximum dimensions, width × extension: 600 cm × 400 cm (with tracfix system)
- intermediate sizes are available

Roller tube and lateral bearings

- round roller tube Ø 85 mm with keyway, galvanised steel – excellent stability, ensures near perfect cover performance even at the largest widths
- the roller tube bearing is made of stainless steel

Awning profiles

- extruded aluminium, in façade quality, powder coated
- cassette profile in two pieces, round, height × depth 125 mm × 125 mm
- guide tracks angular, rounded edges, width × height 52 mm × 52 mm
- front profile rounded at the front, height × depth 110 mm × 52 mm, shadeplus profile height × depth 139 mm × 66 mm

Side caps

- the cassette end caps are made of die-cast aluminium, in two parts, powder coated
- the front profile end caps are made of high-quality plastic, powder coated

Fixture brackets

- extruded aluminium, powder coated
- cassette is self-supporting on guide tracks
- brackets for the guide tracks: flat track brackets, stand-off brackets, reveal fixture
- standard bracket heights: 20 mm / 85 mm / 105 mm / 145 mm (bespoke heights can be ordered)
- other accessories are available

01 **Frame colours**

02 markilux frame colours without surcharge

03 traffic white RAL 9016



04 metallic aluminium RAL 9006



05 grey brown, similar to RAL 8019



06 off-white textured finish, 5233 ¹⁾



07 stone grey metallic, 5215 ¹⁾

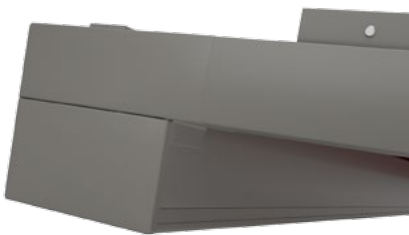

08 anthracite metallic, 5204 ¹⁾



09 Havana brown textured finish, 5229 ¹⁾



18

Non-standard powder-coated finish

Bespoke frame colours at a surcharge – matt, metallic and pearl finishes as well as other colour ranges (DB, Tiger etc.) on request. All frame colours are available at a surcharge with enhanced corrosion protection.

1) textured finish

Colours may differ slightly from those depicted in both hue and finish.

Dimensions and configuration options

Single unit

		Awning fixture width										Minimum fixture width	
		150	200	250	300	350	400	450	500	550	600		
Order dimensions		60	151	201	251	301	351	401	451	501	551	Hard-wired motor	Radio-contr. motor
		150	200	250	300	350	400	450	500	550	600		
Overall width		+ 5.4											
H	150 ¹⁾											60 / 72 ¹⁾	70 / 82 ¹⁾
	200 ¹⁾												
	250 ¹⁾												
	300 ¹⁾											107 ³⁾	107 ³⁾
	350 ¹⁾												
	400 ¹⁾	2)	2)	2)	2)	2)	2)	2)	2)	2)	2)		
	450	2)	2)	2)	2)	2)	2)	2)	2)	2)	2)		
	500	2)	2)	2)	2)	2)	2)	—	—	—	—		
	550	2)	2)	2)	2)	2)	2)	—	—	—	—		
600	2)	2)	2)	2)	2)	2)	—	—	—	—			

dimensions in cm

- 1) = tracfix (optional). Only with motor drive
- 2) = wind resistance class 2, all other sizes meet wind resistance class 3
- 3) = from an extension of 281 cm
- H = extension

- = 2 brackets
- = 3 brackets
- = 3 brackets, 1 stainless steel cover support wire

Operation	standard	optional
crank handle	✓ ¹⁾	—
hard-wired motor	✓ ²⁾	—
silentec motor (optionally with an external io / RTS receiver) ¹⁾	—	—
radio-controlled motor io, 868 MHz	—	✓
radio-controlled motor RTS, 433 MHz	—	✓
radio-controlled motor RTS, 433 MHz with manual override ¹⁾	—	—

- 1) not available in tracfix units
- 2) in tracfix units

Coupled Awning

not available

Shadeplus / drop valance	standard	optional
height depends on the fabric series, see table "shadeplus / drop valance cover"		
minimum awning fixture width 201 cm, maximum 500 cm		
crank handle	✓	—
hard-wired motor	—	—
radio-controlled motor io, 868 MHz	—	—
radio-controlled motor RTS, 433 MHz	—	—

Optional accessories

- tracfix – eliminates gap between cover and guide track
- manual drop valance
- LED-Line in the guide tracks on both sides
- LED-Line in the cover support tube¹⁾
- LED-Spots in the cover support tube¹⁾
- LED-Spots in the cassette
- infrared heater 2000 W / 2500 W
- infrared heater 2500 W with integrated radio-controlled receiver 868 MHz io
- automatic controls (light, wind, rain)

N.B! – Important background information can be found in the chapter "Optional Accessories".

- 1) LED-Line and LED-Spotlights cannot be combined with one another

	Awning cover	fabric range no.	standard	optional	fixture width	unit height	cover manufacture		
01	sunvas	301.. / 309..-315..	✓	—		≤ 450	LN		
02					≤ 600	≤ 400	LN		
03	sunsilk	324.. / 325.. / 328.. / 369..	✓	—		≤ 450	LN		
04					≤ 600	≤ 400	LN		
05	sunvas (250 cm)	31008, -09, -13, -16, -18, -25, 27, -28, -31, -36, -37, -57, -58, 31109, -14, -17	✓	—	≤ 250	≤ 250	N		
06					≤ 400	≤ 400	≤ 243	≤ 243	N
07					≤ 400	≤ 400	≥ 244	≥ 244	QN
08					≤ 400	≤ 400	≤ 243	≤ 243	N
09	transolair	338..	—	✓	≤ 400	≥ 244	QN		
10					≤ 400	≥ 244	≤ 400	QN	
11					≥ 401 ≤ 550	≤ 400	LN		
12	sunvas (320 cm)	31008, -09	✓	—	≤ 600	≤ 350	LN		
13					≤ 320		N		
14					≤ 400	≤ 313	N		
15	vuscreen Alu	317..	—	✓	≤ 400	≥ 314	QN		
16					≤ 400	≤ 313	N		
17					≤ 400	≥ 314	QN		
18					≤ 400	≤ 243	N		
19	Soltis Perform 92	92-20..	—	✓	≤ 400	≥ 244	QN		
20					≤ 400	≤ 400	QN		
21					> 400	≤ 250	N		
22	perla and perla FR	370.. und 374.. / 375..	—	—	≤ 400	≤ 250	N		
23					≤ 400	≥ 244	QN		
24					> 400	≤ 250	N		
25	perla	370..	—	—	≤ 185	≤ 300	N		
26					≤ 400	≤ 194	N		
27					≥ 186 ≤ 400	≥ 195 ≤ 300	QN		
28					≤ 185	≤ 300	N		
29	perla FR	374.. / 375..	—	—	≤ 400	≤ 194	N		
30					≥ 186 ≤ 400	≥ 195 ≤ 300	QN		

18

	shadeplus / drop valance cover ¹⁾	fabric range no.	standard	optional	fixture width	unit height	cover manufacture
19	sunvas	301.. / 309..-315..	✓	—	≤ 500	150	LN
20					≤ 500	210	QN
21	sunsilk	324.. / 325.. / 328.. / 369..	✓	—	≤ 500	150	LN
22					≤ 500	210	QN
23	transolair	338..	—	✓	≤ 500	210	N
24	vuscreen Alu	317..	—	✓	≤ 500	150	N
25	Soltis Perform 92	92-20..	—	✓	≤ 500	210	QN
26	glass fibre screen	272..	—	—			
27	perlotex	331.. / 332..	—	—			
28	perla	370..	—	—			
29	perla FR	374.. / 375..	—	—			

 = tracfix

1) = the width of the awning cover is narrower than that of the awning.

N = seamless

LN = vertical seam(s), panel width usually 120 cm

QN = horizontal seam(s) – with striped patterns the stripes run horizontally,
therefore plain patterns are recommended

dimensions in cm

Lighting options

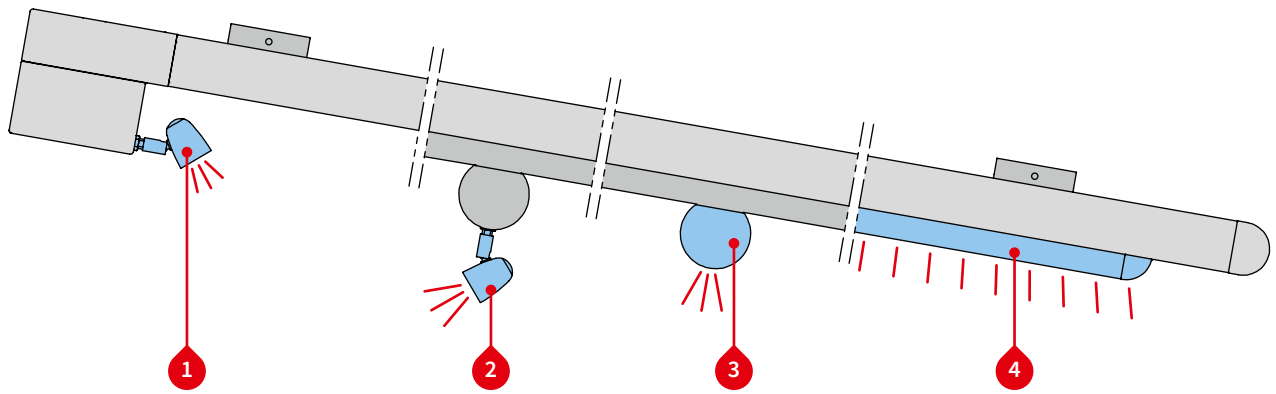

Lighting options

- 1 LED-Spots in the cassette
- 2 LED-Spots in the cover support tube ¹⁾
- 3 LED-Line in the cover support tube ¹⁾
- 4 LED-Line in the guide tracks on both sides

Control

	standard	optional
on/off switch	—	✓
radio-controlled dimmer io 868 MHz	✓	—
radio-controlled dimmer RTS 433 MHz	—	✓

For combination possibilities please view section “Dimension overview lighting options”

1) LED-Line and LED-Spotlights cannot be combined with one another

Distribution of the LED-Spots

1 and 2 in the cassette and in the cover support tube

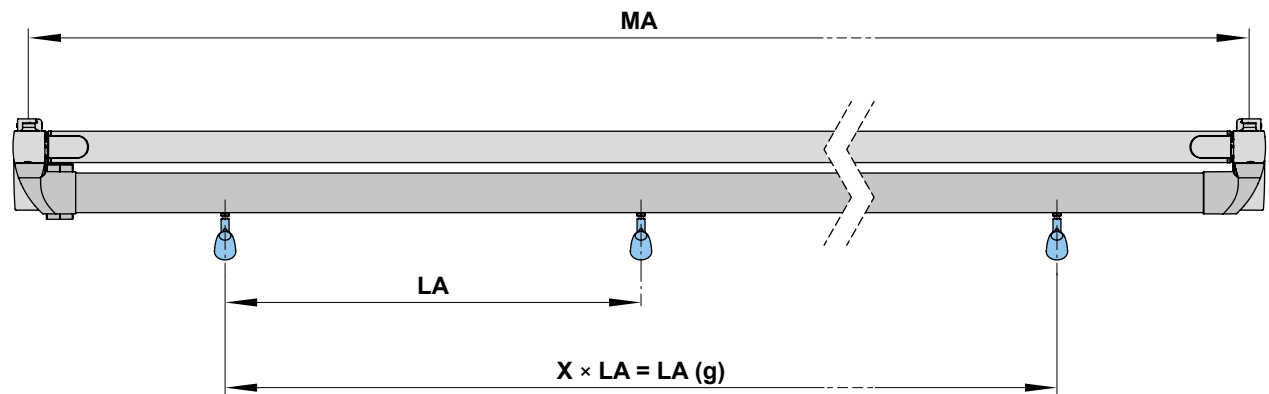

Awning fixture width	No. of spotlights	LA	LA (g)
150–250	3	65	130
251–300	3	98	196
301–350	3	98	196
351–400	4	98	294
401–450	4	98	294
451–500	5	98	392
501–550	5	98	392
551–600	6	98	490

dimensions in cm

LA (g) = distance between the spotlights (total)

MA = order dimension = awning fixture width = fixture width

01 **1** and **2** LED-Spots in the cassette and in the cover support tube

02 **Technical specification**

operating voltage	230 V, 50 Hz
power output of an LED-Spotlight	5 W
bulbs	LED (12 V)
number of transformers	1
light temperature	2700 K
IP protection class	IP 44
service life	approx. 20.000 h

K O (H* SPL

This luminaire contains built-in LED lamps.

A++
A+
A
B
C
D
E
F

LED

The lamps cannot be changed in the luminaire.

874/2012

03
04
05
06
07
08

09
10
11
12

13
14

15 **3** and **4** LED-Line in the cover support tube and in the guide tracks

16 **Technical specification**

operating voltage	230 V, 50 Hz
power output per metre	10 W
bulbs	LED (12 V)
number of LEDs	120 units / m
number of transformers	1
light temperature	3200 K
IP protection class	IP 44
service life	approx. 15.000 h

K O (H* LFD

This luminaire contains built-in LED lamps.

A++
A+
A
B
C
D
E
F

LED

The lamps cannot be changed in the luminaire.

874/2012

17
18
19
20

Fixtures, fittings and accessories

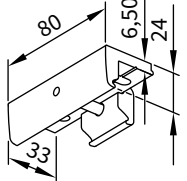
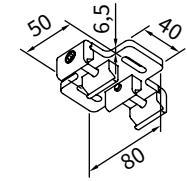
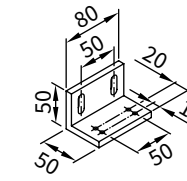
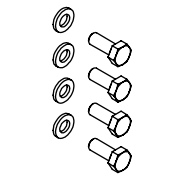
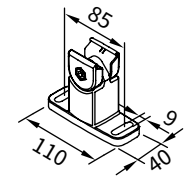
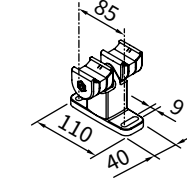
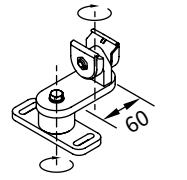
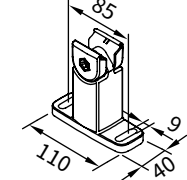
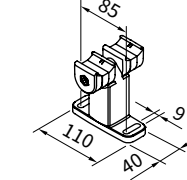
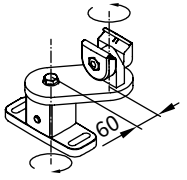
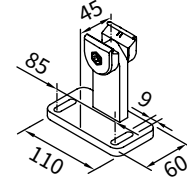
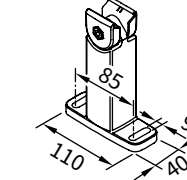
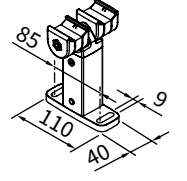
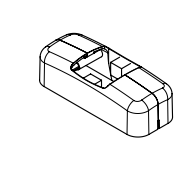
 <p>flat track bracket fixture type 10 / 15</p> <p>78548.</p>	 <p>double track bracket flat 2 single units</p> <p>73627.</p>	 <p>additional angled bracket for the bearing, gearbox and motor sides fixture type 15 50 × 50 × 80 mm</p> <p>78719.</p>	01 02 03 04 05
 <p>accessories for two angled brackets 78719.</p> <p>787211</p>	 <p>track bracket with adjustable head fixture type 20 80 mm</p> <p>73624.</p>	 <p>double track bracket with adjustable head central bracket for 2 single units next to each other 80 mm</p> <p>73631.</p>	06 07 08
 <p>universal track bracket 80 mm</p> <p>73629.</p>	 <p>track bracket with adjustable head fixture type 21 100 mm</p> <p>76046.</p>	 <p>double track bracket with adjustable head central bracket for 2 single units next to one another 100 mm</p> <p>73634.</p>	09 10 11 12
 <p>universal track bracket 100 mm</p> <p>76054.</p>	 <p>track bracket with adjustable foot plate 100 mm</p> <p>76199.</p>	 <p>track bracket with adjustable head fixture type 22 140 mm</p> <p>76048.</p>	13 14 15 16
 <p>double track bracket with adjustable head 140 mm</p> <p>73636.</p>	 <p>cover cap for square track bracket standard accessory for bracket</p> <p>76718.</p>		17 18 19 20

01
02
03
04
05
06
07
08
09
10
11
12
13
14
15
16
17
18
19
20

Fixtures, fittings and accessories

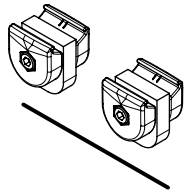

sprung bracket with stainless steel cover support wire
included with the delivery

73639. and 771401

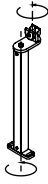

universal track bracket with adjustable head
140-500 mm

76053.

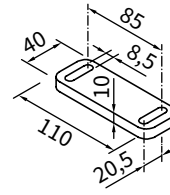

spacer plate for track bracket
110 × 40 × 10 mm

78570.

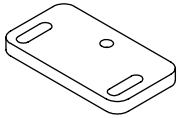

adapter plate for a track bracket
110 × 60 mm

78158.

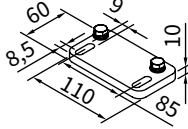

adapter plate for track bracket

78165.

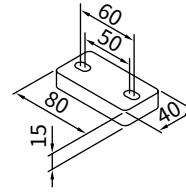

spacer plate for double flat track bracket
80 × 40 × 15 mm

73742.

Fixture types

10

Clearance 20 mm

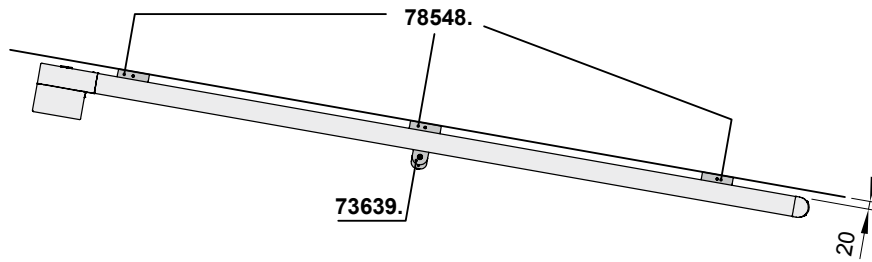

15

By angled bracket to the side

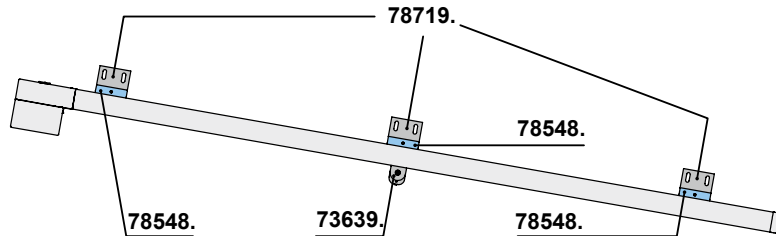

20

Clearance 85 mm

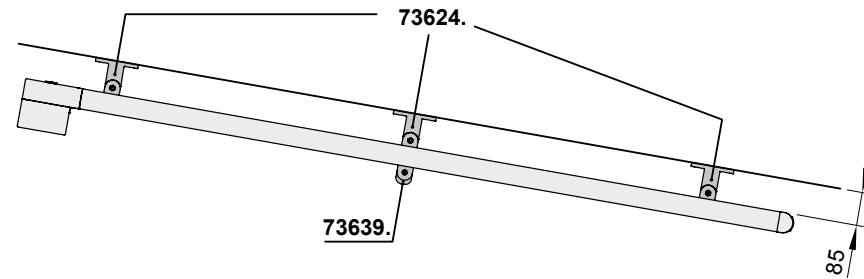

21

Clearance 105 mm

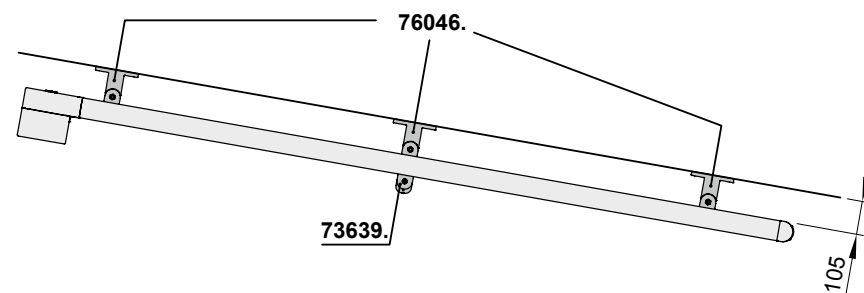

22

Clearance 145 mm

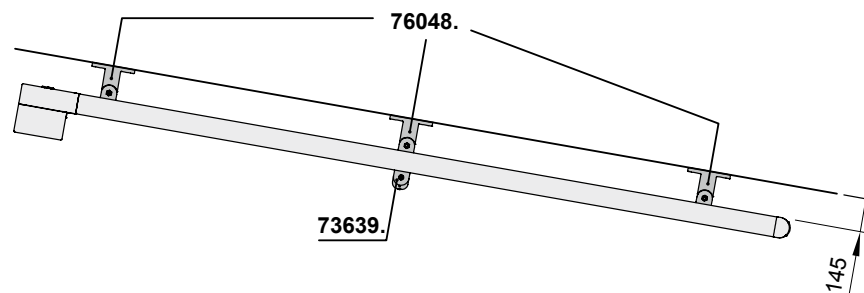

Individual choice of brackets:

see "Fixtures, fittings and accessories". When extension > 300 cm always with 3 brackets per guide track.

During extension and retraction the cover may sag.

Cover support wires and brackets (73639.) are only supplied with the markilux 779 without tracfix at certain sizes. A bracket should always be placed where these are positioned.

01
02
03
04
05
06
07
08
09
10
11
12
13
14
15
16
17
18
19
20

Fixture types

Dimension overview

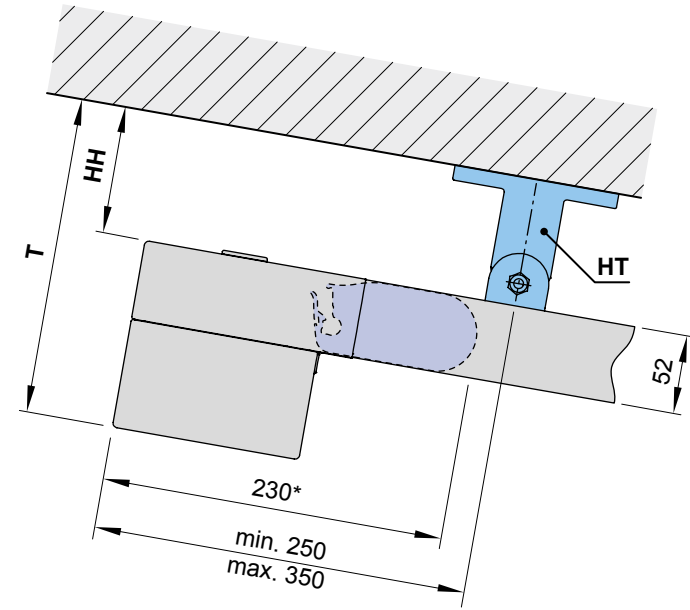

Fixture type 10

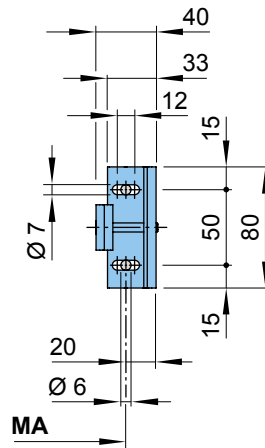

Fixture types 20, 21 and 22

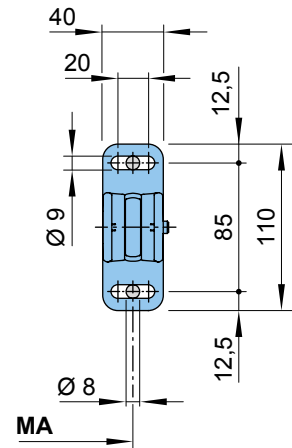

	Fixture type 10	Fixture type 20	Fixture type 21	Fixture type 22
HT	= bracket	78548.	73624.	76046.
HH	= bracket height	20	85	105
T	= overall height	150	215	235
MA	= <i>order dimension</i> = awning fixture width = fixture width			
*	= depth of cassette including front profile, retracted			

Dimension overview

Single unit

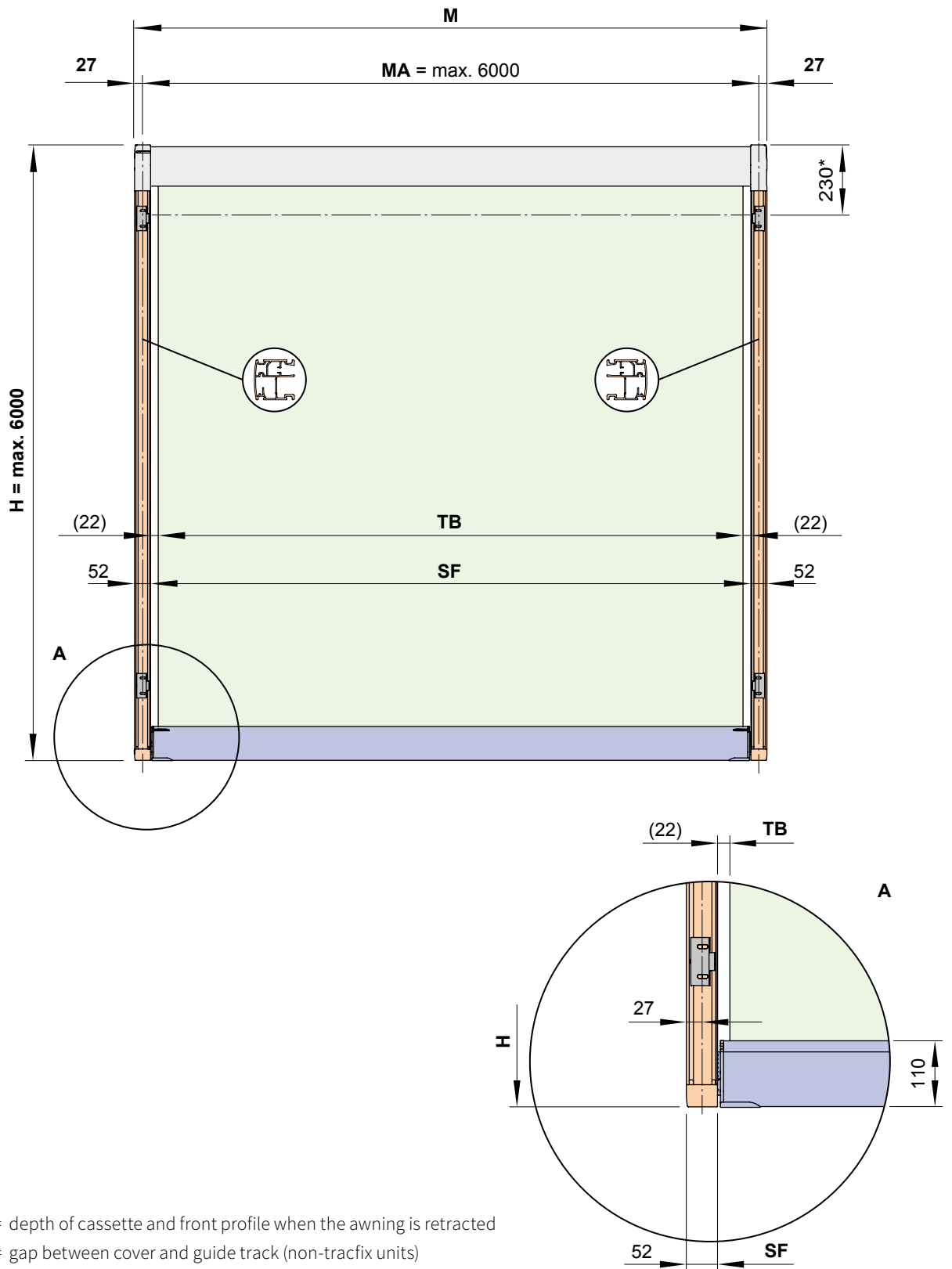

- * = depth of cassette and front profile when the awning is retracted
- (...) = gap between cover and guide track (non-tracfix units)
- H** = *order dimension* = extension
- M** = overall awning width
- MA** = *order dimension* = awning fixture width = fixture width
- TB** = cover width (in non-tracfix systems)
- SF** = visible cover (in tracfix systems)

dimensions in mm

01
02
03
04
05
06
07
08
09
10
11
12
13
14
15
16
17
18
19
20

Dimension overview

Two single units - fixture via double track brackets

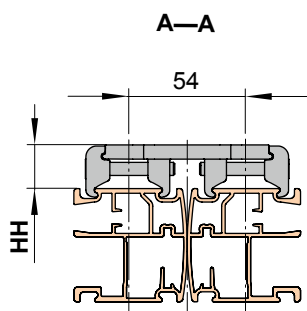
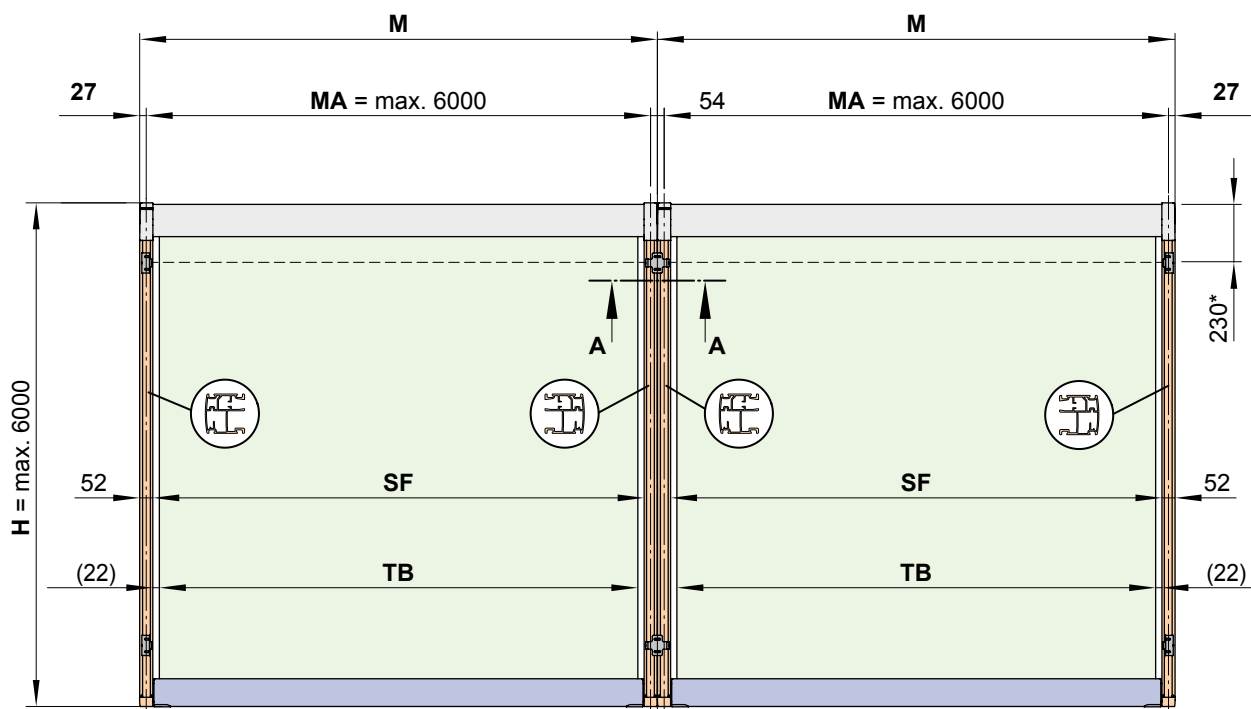

18

* = depth of cassette and front profile when the awning is retracted

(...) = gap between cover and guide track (non-tracfix units)

H = *order dimension* = extension

HH = bracket height

M = overall awning width

MA = *order dimension* = awning fixture width = fixture width

TB = cover width (in non-tracfix systems)

SF = visible cover (in tracfix systems)

dimensions in mm

Dimension overview fixture type 10

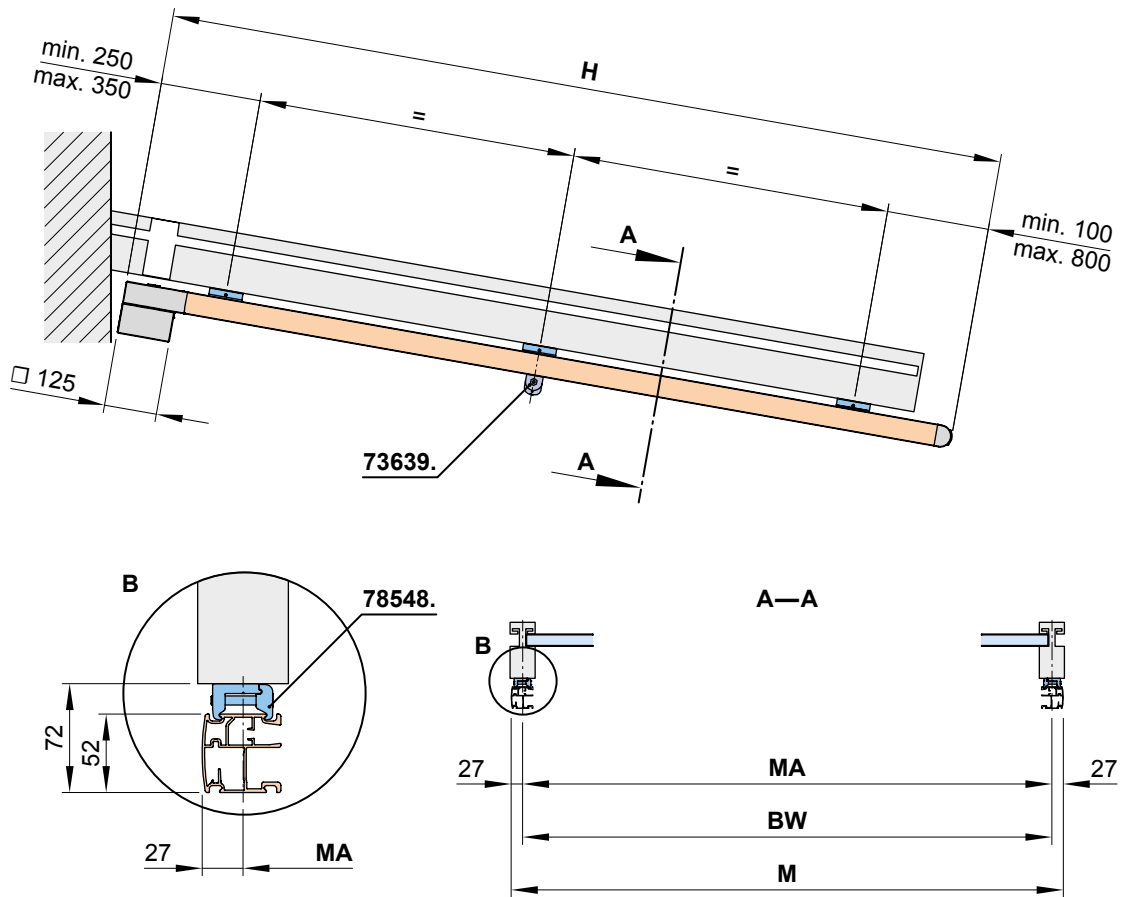

- BW** = width between fixture points on the conservatory
- H** = *order dimension* = extension
- M** = overall awning width
- MA** = *order dimension* = awning fixture width = fixture width

dimensions in mm

01
02
03
04
05
06
07
08
09
10
11
12
13
14
15
16
17
18
19
20

Dimension overview fixture type 15

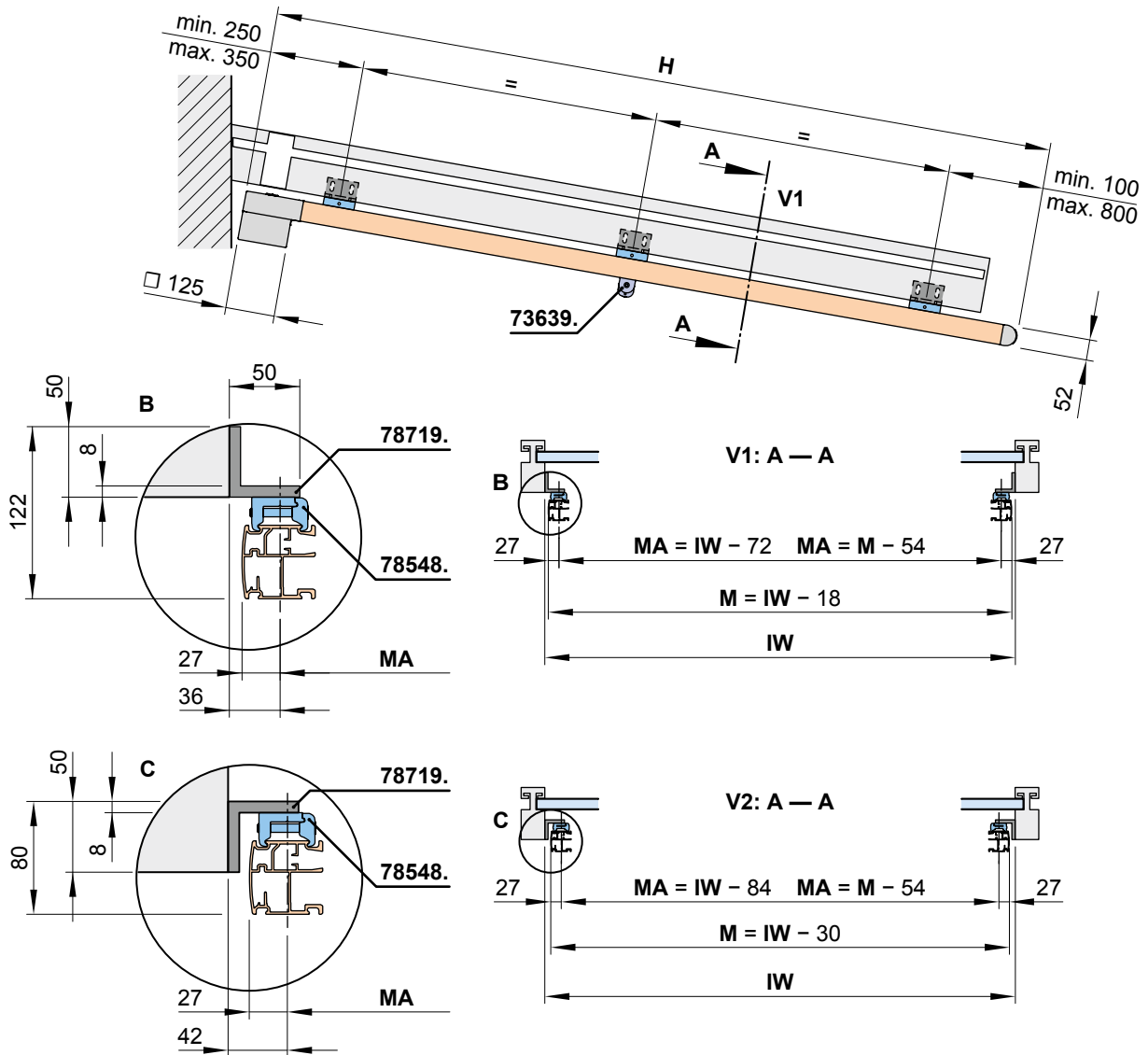

18

- H = order dimension = extension
- IW = interior conservatory dimension
- M = overall awning width
- MA = order dimension = awning fixture width = fixture width
- V1, V2 = variants

dimensions in mm

Dimension overview fixture types 20, 21, 22

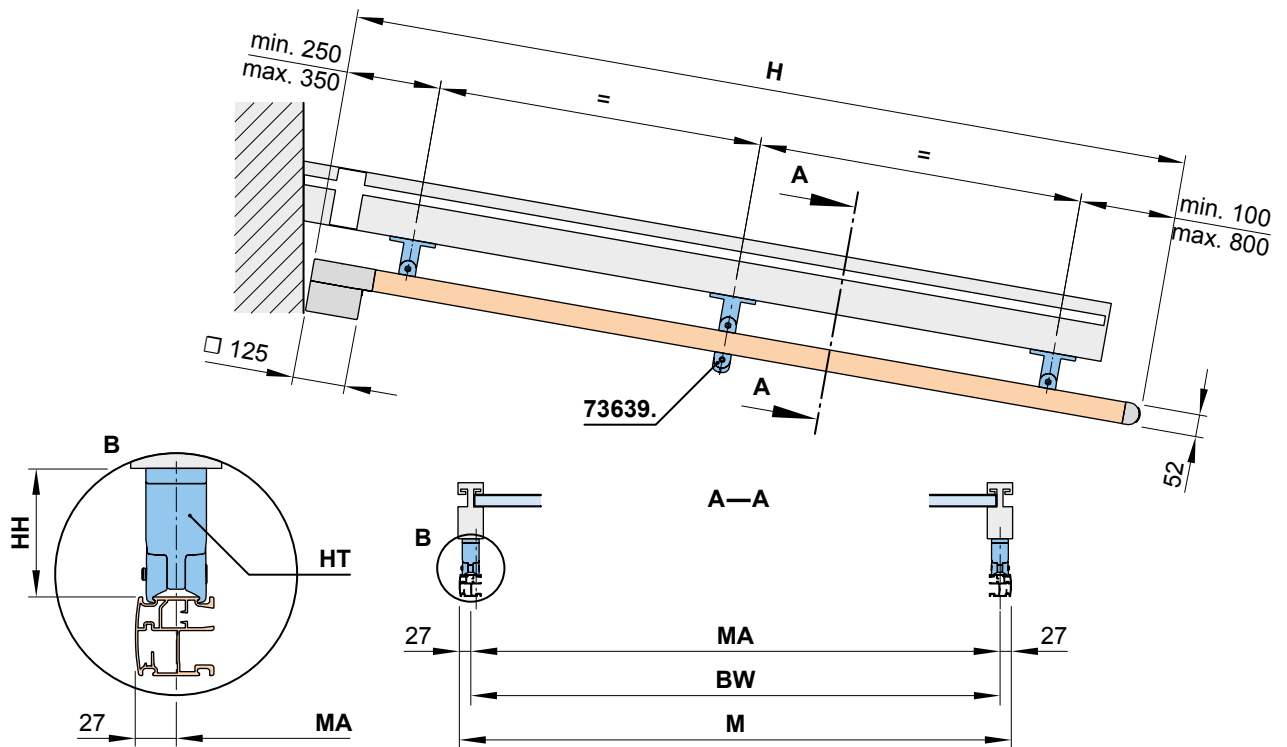

01
02
03
04
05
06
07
08
09
10
11
12
13
14
15
16
17
18
19
20

- BW** = width between fixture points on the conservatory
- H** = *order dimension* = extension
- HH** = bracket height (for dimensions please refer to "Dimension overview")
- HT** = bracket
- M** = overall awning width
- MA** = *order dimension* = awning fixture width = fixture width

dimensions in mm

01 Dimension overview, shadeplus

02
03
04
05
06
07
08
09
10
11
12
13
14
15
16
17
18
19
20

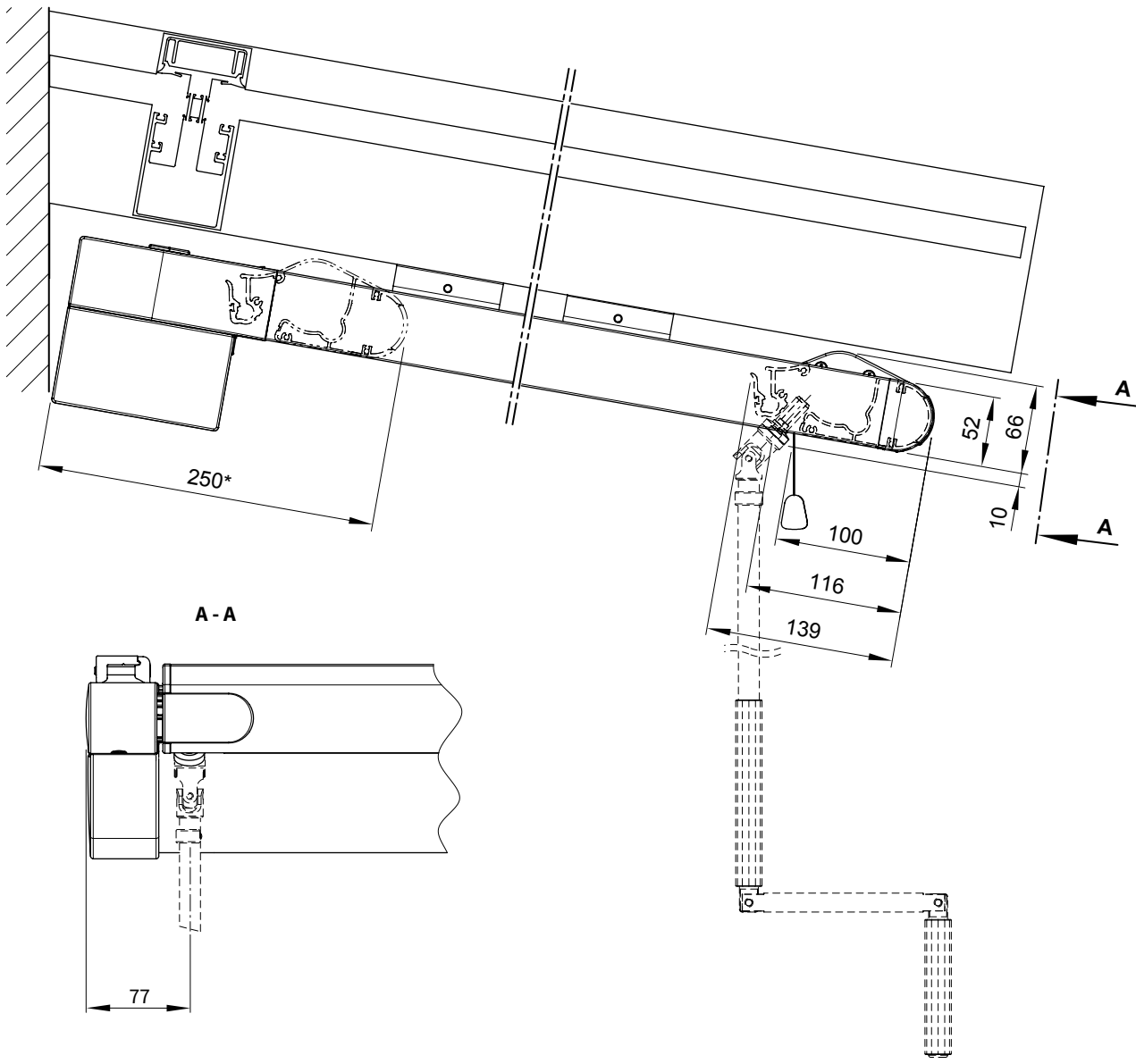

* = depth of cassette and front profile when the awning is retracted

dimensions in mm

Gearbox crank handle position

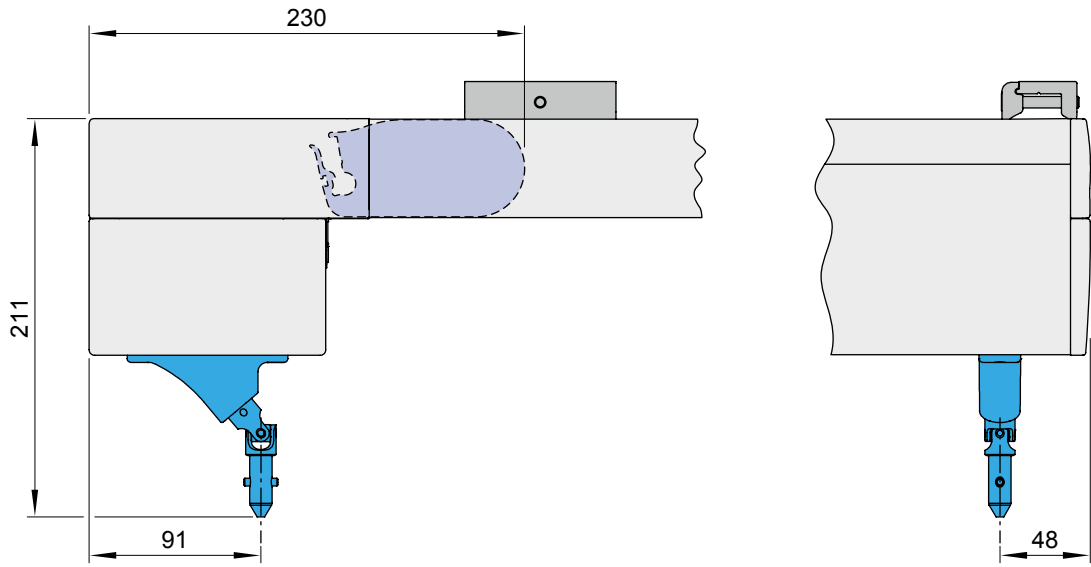

Motor cable exit point

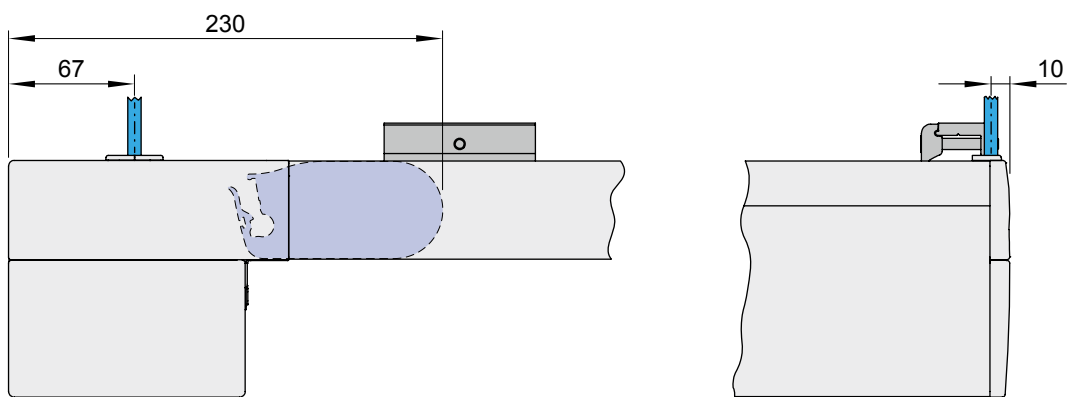

- 01
- 02
- 03
- 04
- 05
- 06
- 07
- 08
- 09
- 10
- 11
- 12
- 13
- 14
- 15
- 16
- 17
- 18
- 19
- 20

18

dimensions in mm

Dimension overview lighting options

Option 1: LED-Line in the guide tracks, electronic components in an E box

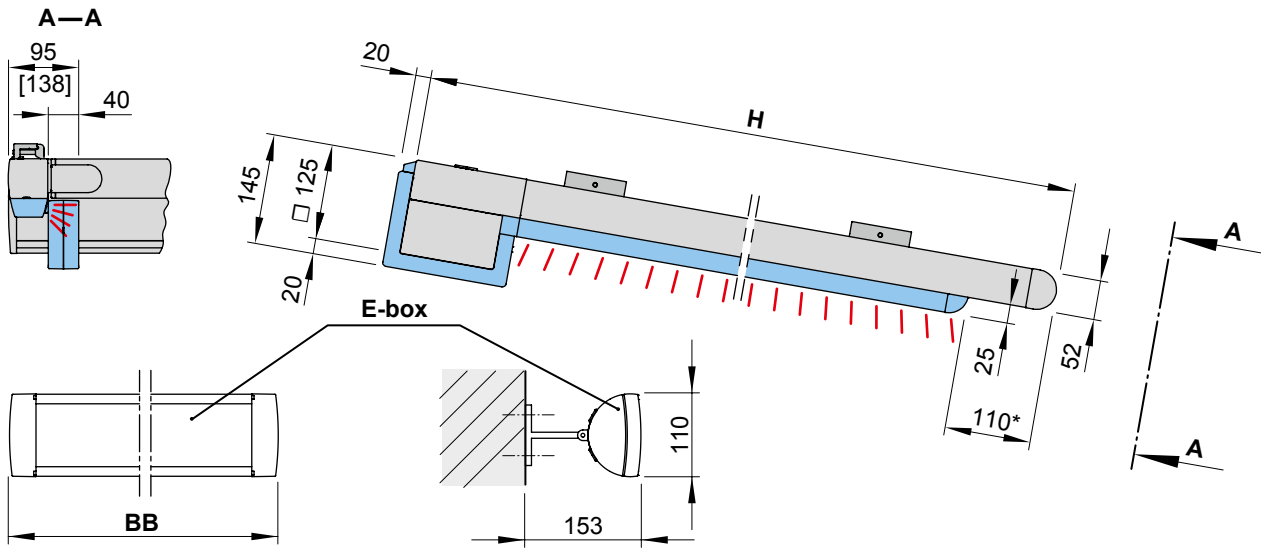

Option 1a (from an extension of 401 cm): LED-Line in the guide tracks, stainless steel cover support wires, electronic components in an E box

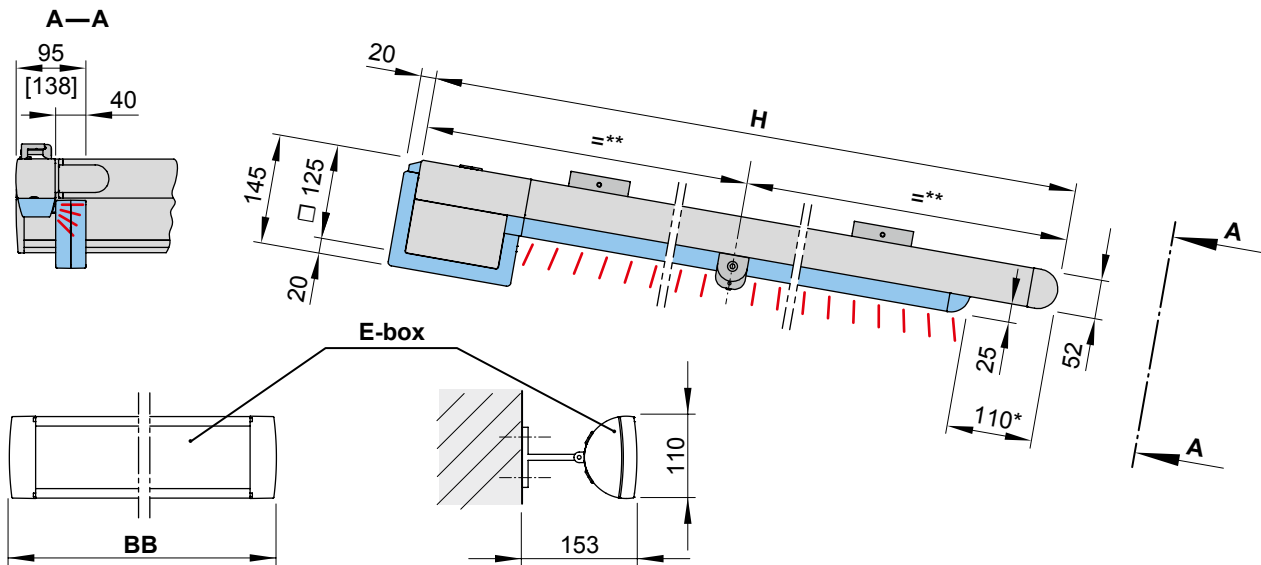

* = 110 mm standard, 36 mm optional

** = cover support wire centred (standard), other positions are possible on request

[...] = for shadeplus and lighting

BB = order width

E-box = see "E-box"

H = order dimension = extension

dimensions in mm

Dimension overview lighting options

Option 2: LED-Line in the cover support tube, electronic components in the cover support tube

Option 3: LED-Line in the cover support tube and in the guide tracks, electronic components in the cover support tube

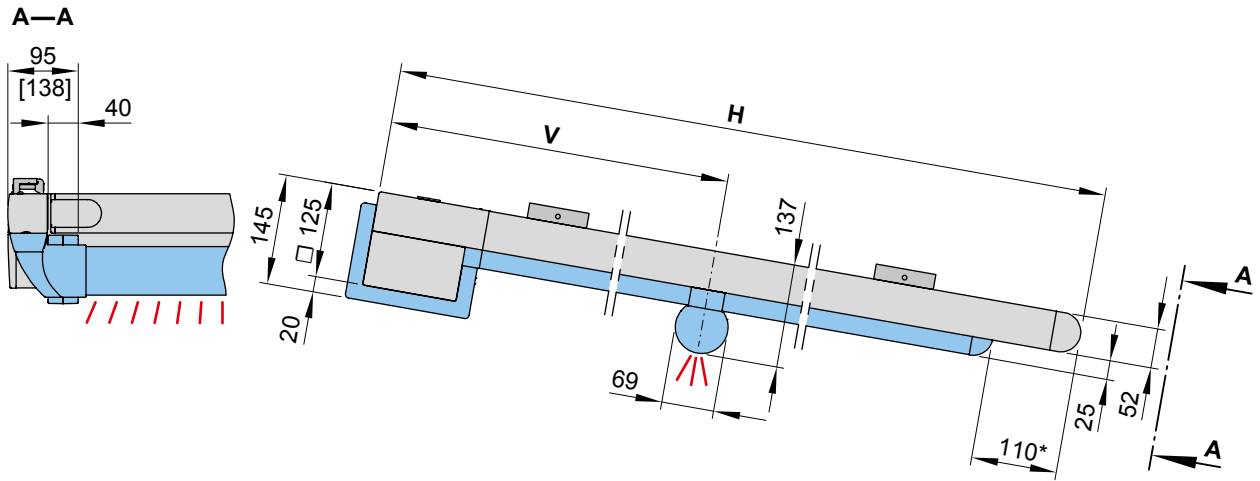

Option 4: LED-Line in two cover support tubes, electronic components in the cover support tube

Option 5: LED-Line in two cover support tubes and in the guide tracks, electronic components in the cover support tube

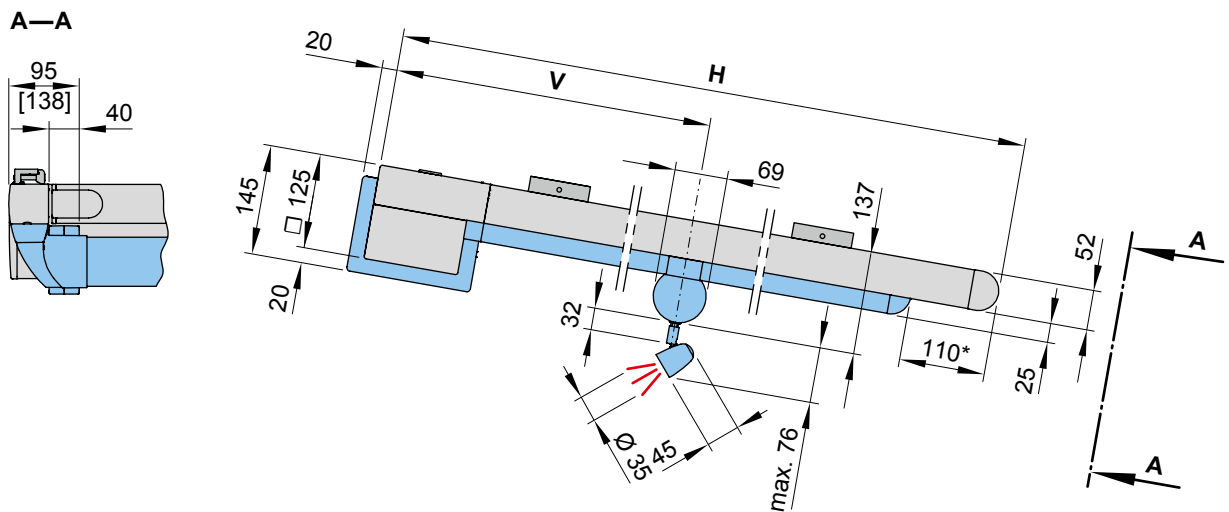

* = 110 mm standard, 36 mm optional

[...] = for shadeplus and lighting

V = lighting position from back of cassette. Standard: centred ($V = H \div 2$).

Optionally this can be stipulated when ordering ($V \text{ min.} = 500 \text{ mm. } V \text{ max.} = H - 500 \text{ mm}$)

H = *order dimension* = extension

dimensions in mm

Dimension overview lighting options

Option 6: LED-Spots in the cover support tube, electronic components in the cover support tube

Option 7: LED-Spots in the cover support tube and LED-Line in the guide tracks, electronic components in the cover support tube

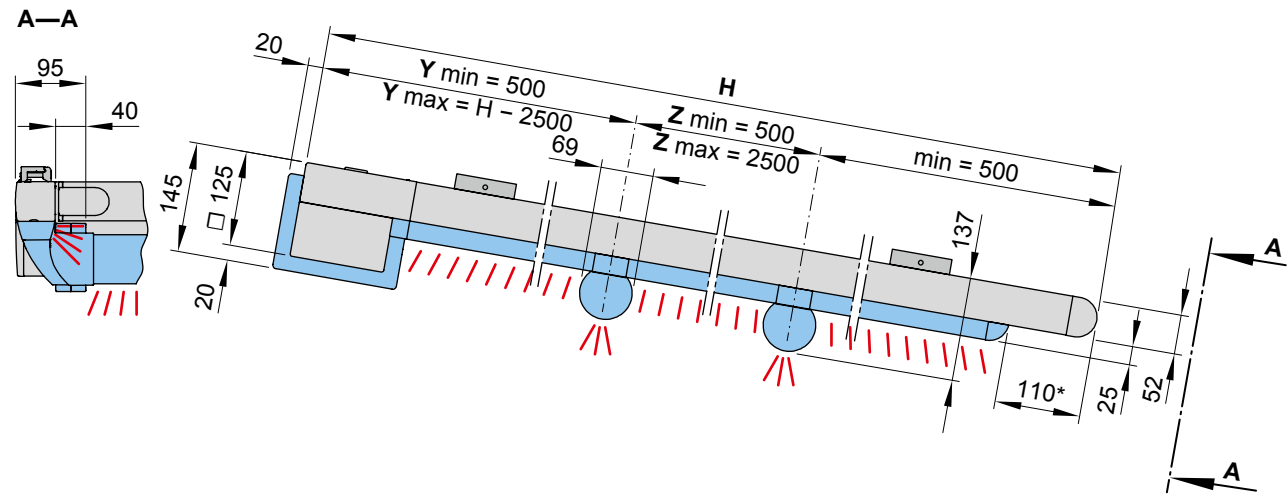

Option 8: LED-Spots in two cover support tubes, electronic components in the cover support tube

Option 9: LED-Spots in two cover support tubes and LED-Line in the guide tracks, electronic components in the cover support tube

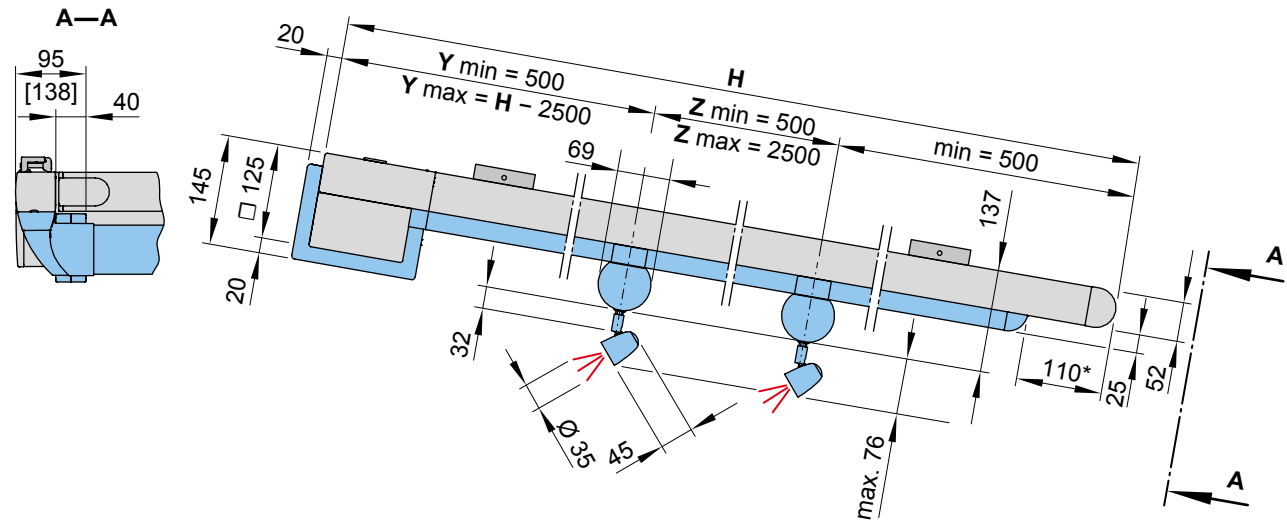

* = 110 mm standard, 36 mm optional

[...] = for shadeplus and lighting

H = *order dimension* = extension

V = lighting position from back of cassette. Standard: centred ($V = H \div 2$).

Optionally this can be stipulated when ordering ($V \text{ min.} = 500 \text{ mm. } V \text{ max.} = H - 500 \text{ mm}$)

Y = distance from the rear of the cassette to the centre of the 1st cover support tube

Z = distance from the centre of the 1st cover support tube to the centre of the 2nd

dimensions in mm

Dimension overview lighting options

Option 10: LED-Spots in the cassette (can be combined at will with options 1-9), electronic components in an E box or in the cover support tube

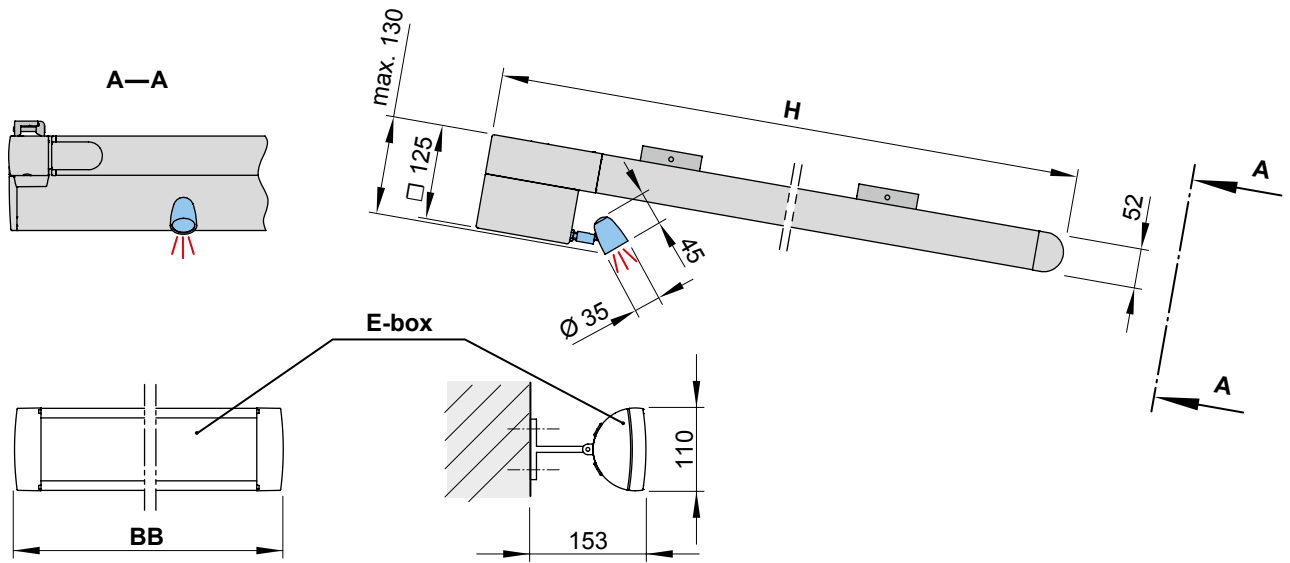

01
02
03
04
05
06
07
08
09
10
11
12
13
14
15
16
17
18
19
20

BB = order width

E-box = see "E-box"

H = *order dimension* = extension

dimensions in mm

E-box

Dimension overview

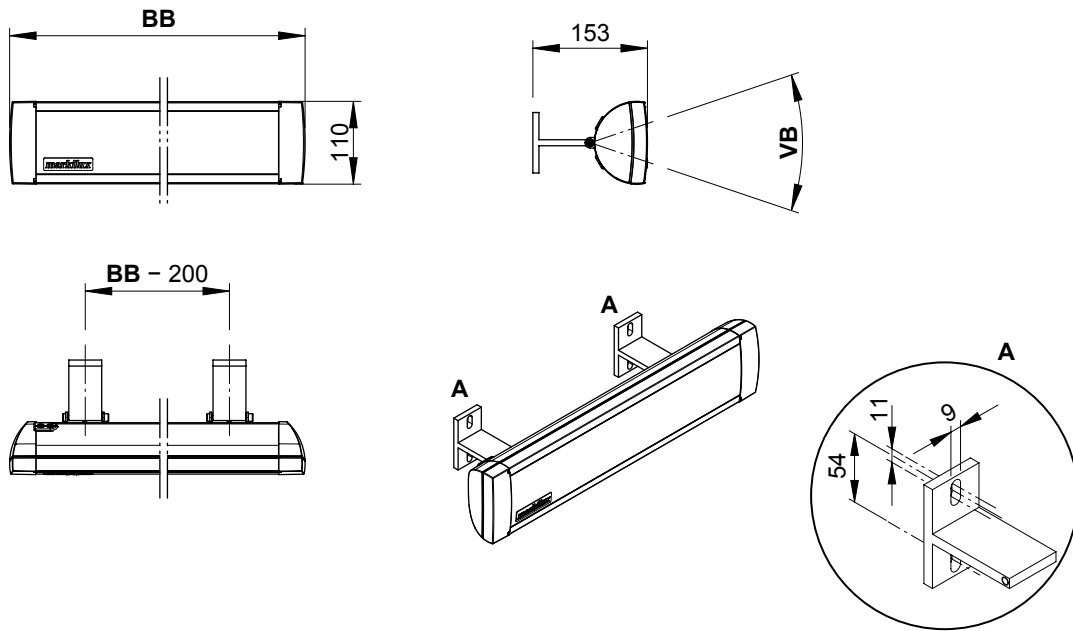

Dimension overview and applications

wireless technology
extension H

RTS (433 MHz)		868 MHz io	
< 330 cm	≥ 330 cm	< 330 cm	≥ 330 cm

Lighting options

LED-Line in the guide tracks with or without cover support wire	E-box M 71850. BB = 500 mm	E-box G 71873. BB = 700 mm	
LED-Spots in the cover cassette	E-box M 71850. BB = 500 mm		
LED-Line in the guide tracks and LED-Spots in the cassette	E-box G 71873. BB = 700 mm	E-box L 71874. BB = 1200 mm	

for independent use

E-box I 71851.BB = independent use

BB = order width
VB = adjustment range

dimensions in mm

Dimensions for taking measurements

Awning without lighting

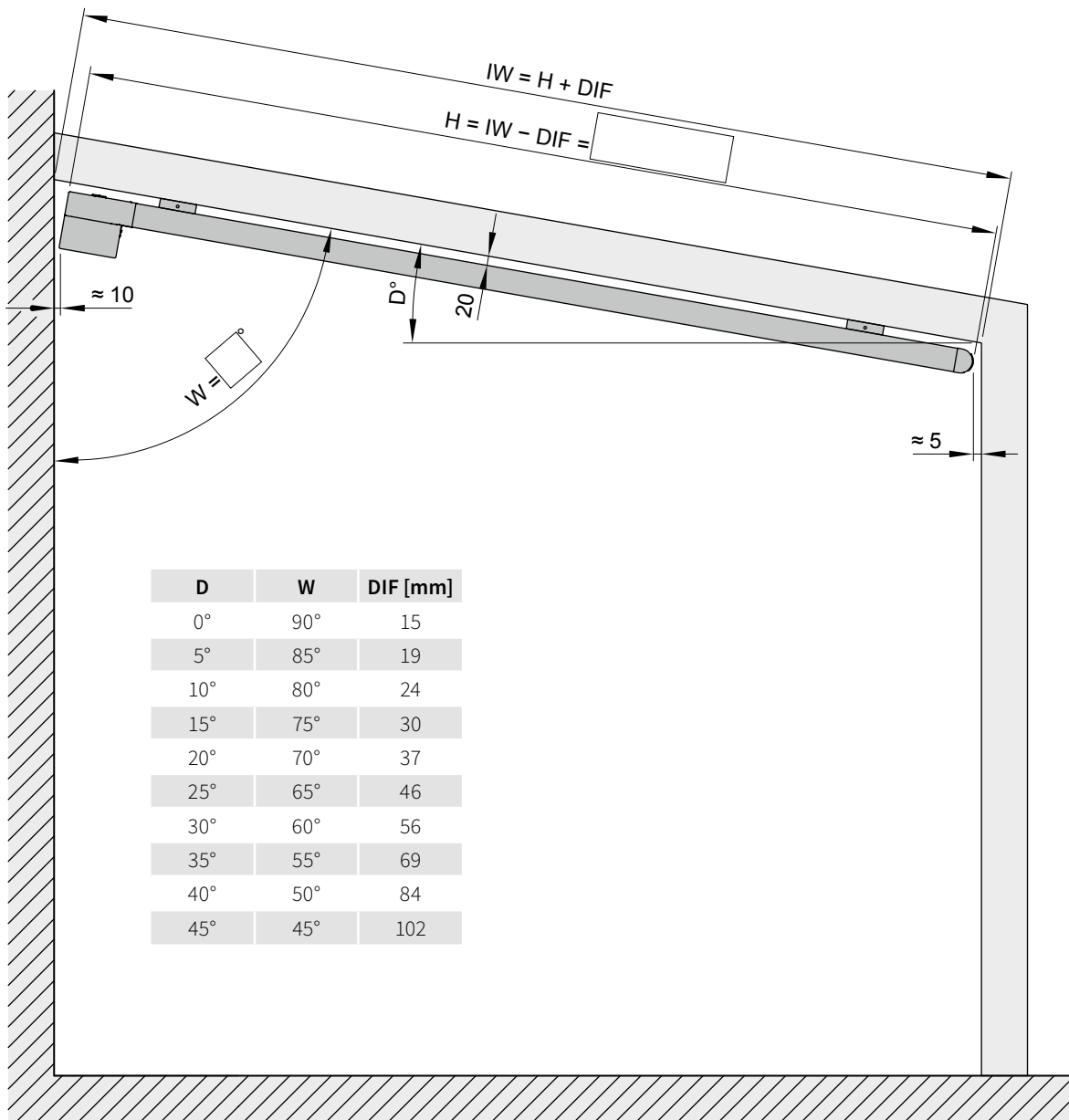

Orders are to be submitted with all the dimensions shown in the diagram!

- D** = roof pitch (in °)
- DIF** = difference interior conservatory measurement to extension H
- H** = *order dimension* = nominal extension = IW - DIF (see table)
- IW** = interior conservatory dimension
- W** = awning pitch (in °)

dimensions in mm

01
02
03
04
05
06
07
08
09
10
11
12
13
14
15
16
17
18
19
20

Dimensions for taking measurements

Awning with lighting

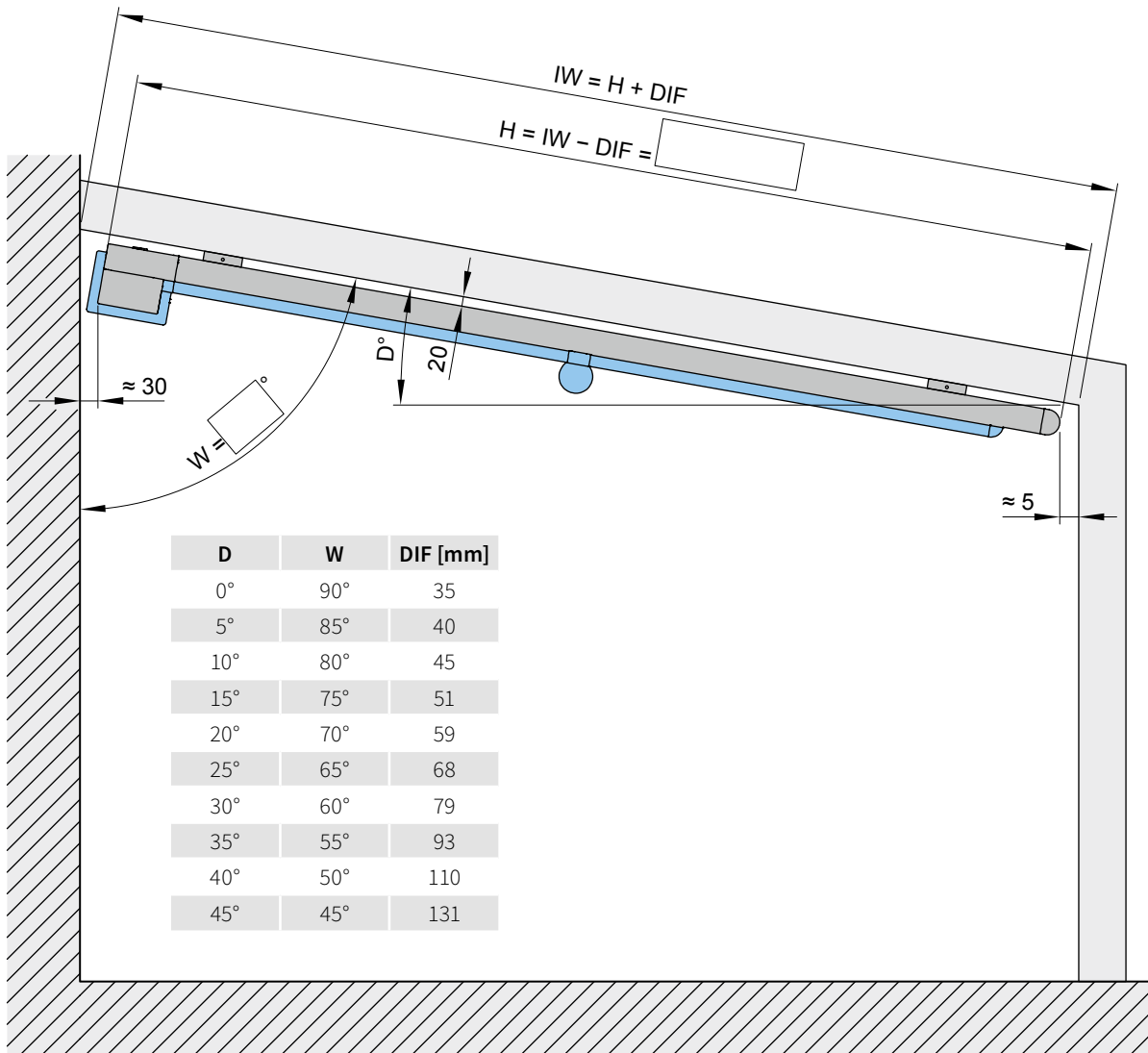

18

Orders are to be submitted with all the dimensions shown in the diagram!

- D** = roof pitch (in °)
- DIF** = difference interior conservatory measurement to extension H
- H** = *order dimension* = nominal extension = IW - DIF (see table)
- IW** = interior conservatory dimension
- W** = awning pitch (in °)

dimensions in mm